

COLDKIT MATRIX]

Modular Cold Room



MORE TECHNOLOGY | MORE OPTIONS
MORE DESIGN | MORE SAFETY

...More MATRIX



The modular cold room with endless possibilities

MATRIX is the cold room specially designed to meet the most demanding cold storage and preservation needs of hotels, restaurants, catering companies, shops, and industrial kitchens with high production volumes.

With its unique design and an unrivalled level of finishes, MATRIX is the cold room with the most customisation options on the market, offering a wide range of sizes, thicknesses and accessories.

Thanks to its modular design, MATRIX is ready to evolve with your company, as you can modify your cold room and adapt it to the needs of your business.

THE ENVIRONMENT

MATRIX is manufactured with environmentally friendly materials (polyurethane insulation without CFCs or HCFCs) produced in modern facilities with state-of-the-art machinery to guarantee the highest levels of quality, while being more energy efficient.

IMMEDIATE AVAILABILITY

We know your business can't wait, which is why we have implemented a decentralised logistics system, with different distribution centres to deal quickly and efficiently with all our customers' orders. This means we are able to guarantee short and reliable delivery times.

WE OFFER THE BEST SERVICE

Our large team of highly qualified professionals can advise you at all times and support you through all phases of your project. We are at your disposal for any help you may need.





page

(04)

What is MATRIX?

page

(10)

Frames and
Doors

page

(14)

Floor Panels

page

(16)

Wall and Roof
Panels

page

(20)

Window
Panels

page

(22)

Angles

page

(28)

Add-ons and
Accessories

What is MATRIX?

MATRIX is the most versatile **modular cold room** on the market, and has been developed to meet the most demanding storage and freezing requirements in large-volume facilities such as restaurants and industrial kitchens, large hotels and catering companies, among others.

The MATRIX cold room has been manufactured using **the highest quality materials**, such as our CFC-free high pressure injected polyurethane (PUR) panels with a density of $40 \text{ kg/m}^3 \pm 2$, which have the reaction to fire rating B-s2,d0 (Euroclass).

Likewise, all the components and accessories that make up the MATRIX camera are made from the best materials, which gives the camera an attractive design, making its appearance and aesthetics unparalleled.

AESTHETICS AND QUALITY

284 STANDARD MODELS

EASY TO TRANSPORT AND ASSEMBLE

COMPETITIVE PRICE

LOW CONSUMPTION

EASY MAINTENANCE

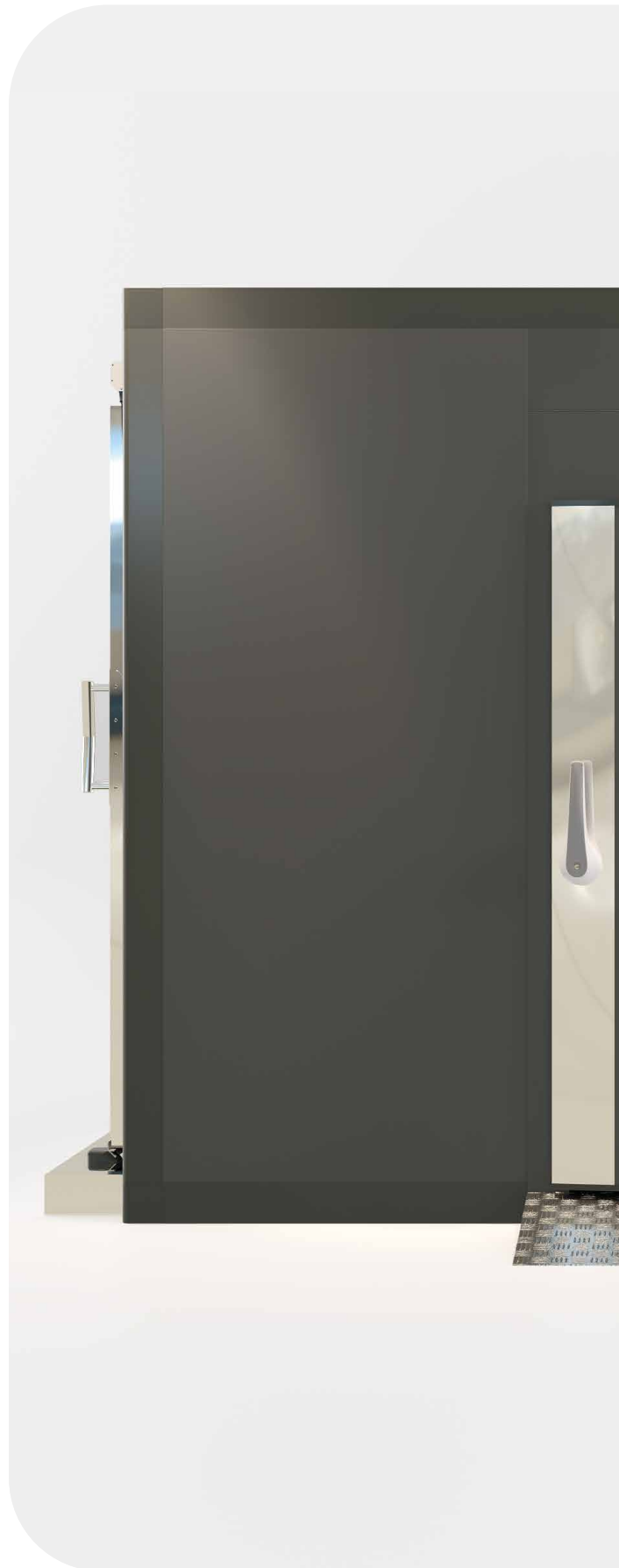

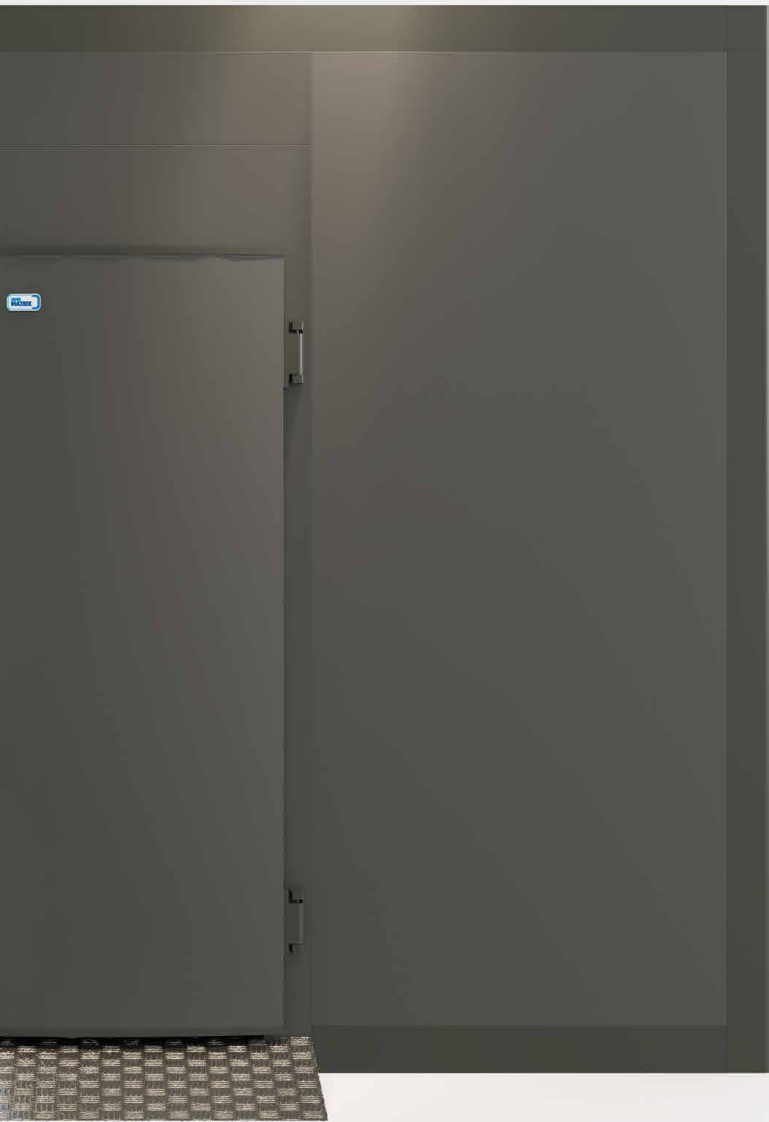

MODULAR COLD ROOM

TOTAL MODULARITY

MATRIX adapts to any space and situation. It has been developed with a modulation of 200 by 200 mm (height, length and width), creating an endless number of possible combinations, and can therefore be installed anywhere. Its modularity goes even further, making it possible to add another Matrix chamber or divide the chamber inside to create different zones, even in terms of temperature, adapting to the different needs that may arise.

EASIER ASSEMBLY

MATRIX has been designed for quick and easy installation. It is assembled from inside the room, without having to cut the panels. Moreover, thanks to the fastening system that uses hooks inserted into the panels, you can set up your MATRIX in no time at all.

PERSONALIZED DESIGN

Matrix has been created so that you can design it according to your company's needs. Choose from different panel thicknesses and sizes. In addition, select what you want it to look like, a standard model or if you want to change the panel's coating.

You can also customize it with our different accessories: pivot doors, service or sliding doors, doors with glasses, panels with windows, slatted curtains, access ramps, data loggers, etc. For floor models, choose one of our different options. MATRIX components include skirting boards, sanitary profiles, pressure balance valves, lighting solutions (even within the sanitary profile), temperature control...

Your business, your MATRIX.

COLDKIT MATRIX] 60 85 1

Endless possibilities

The technical specifications of MATRIX make it a unique cold room:

- Four panel thicknesses available (60, 85, 105, 150 mm).
- Modulation every 200 mm.
- Finish of floor panels in different options and qualities.
- Possibility of internal division and connection of several rooms.
- Wide range of pivot and sliding doors and windows.
- Maximum integration of components for easy cleaning (the electrical resistor is located inside a PVC profile around the door frame).
- Wide range of accessories to meet current health standards and customise the use and functions of your MATRIX room.

It also has a unique aesthetic finish that is characterised by:

- Outer colour basalt grey (RAL 7012).
- Smooth finish for easy cleaning.
- Pivot door with rounded finish on the outside, except for the MATRIX 150 mm model.
- Hinges and lock perfectly integrated into the room assembly.



*Available in two
versions: with and
without floor*



Standard Configuration



Standard Configuration without Floor

05 150

PANEL THICKNESS MM



Accessories

MATRIX has a wide range of accessories that will enable you not only to personalise it as much as possible but also to get the most out of your cold room.

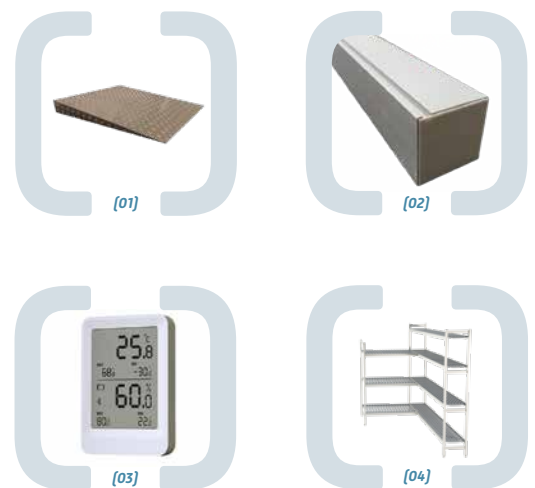

- [01] Access ramp
- [02] Sill
- [03] Data Logger
- [04] Modular Shelving

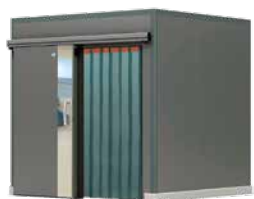

Without Floor - Optional Configurations
[sliding door, strip curtain]



Optional Configurations [window,
ventilation profiles and ramp]



NOW MATRIX IS EVEN BETTER

Launched in 2004, the MATRIX cold room has never stopped evolving and adapting to new market needs, keeping its basic essence and features intact.

Over the past few months, we have conducted intensive re-engineering and design work to further improve the performance of MATRIX while reducing its environmental impact.

As a result of this effort, we have been able to give our cold room more personalisation options, more technology, better design, and greater safety.

NEW BASALT GREY COLOUR

More up to date and in line with the most cutting-edge trends in interior design and decoration, giving your cold room more personality.



PIVOT DOOR

Pivot door with a new design that includes an AISI 304 stainless steel strip to give the MATRIX room a more modern look.



SLIDING DOOR AND GUIDE

The new sliding door from MATRIX has a strip and handle made of high-performance AISI 304 stainless steel. New rail that is quick and easy to install thanks to its clip-on mounting.



NEW LOCK

The new MATRIX lock is stronger and more reliable. It has a more attractive design and is integrated into the camera assembly.



FLOOR OPTIONS

You can now choose from more MATRIX floor options, including a non-slip aluminium floor and an ultra-strong PVC floor, to protect the inside of your room.



DATA LOGGER

With this new device, you will now be able to know and control the environmental conditions inside your MATRIX room at any time and from anywhere.



GLASS DOOR

The new MATRIX glass door for positive rooms combines the best features and technological advances with an impressive, cutting-edge design.



INTERACTIVE WINDOW

Simply by touching this window from the outside, you can switch on the light inside your cold room or open its door, among other possibilities.



ACCESS RAMP

The new MATRIX lightweight access ramp, capable of withstanding up to 800 kg of dynamic load, has a galvanised steel structure and is coated in non-slip aluminium.



INTERIOR PVC COATING

You can now apply a heavy-duty coating to the panels to protect the inside of your MATRIX room from bumps and scratches.



AUTOMATIC SEMI-RECESSED DOOR

The new MATRIX automatic semi-recessed door is equipped with sensors to open it from the outside, a flush spyhole for the 60 mm thickness, and an aluminium trim around the perimeter.



SILL

New sill made of injected PVC which improves the mechanical resistance compared with previous models.



Frames and Doors

FRAMES

The frames of the entire MATRIX range are made in the same way as a panel. The outer side is made of 0.5 mm lacquered galvanised steel sheet and the inner side is made of the same steel sheet.

A rigid polyurethane foam with a density of 40+/- 2 kg/m² is injected between the two sheets. At the time of manufacture, reinforced plastic camlocks are fitted for assembly (in the 200mm module or 400 mm module with the vertical panels).

The thicknesses are the same as for the vertical panels, i.e., 60, 85, 105 and 150 mm. The finish ensures clearance thanks to a PVC profile, which acts both as a thermal break and a heating resistor housing.

PIVOT DOOR



The MATRIX pivot doors have a new design that includes an AISI 304 stainless steel strip to give the room a more modern look.

The pivot doors for MATRIX 60, 85, 105 are convex, except for the doors with clearance 2200x1200 mm and 2200x1500 mm which are flat. In the case of MATRIX 150, all pivot doors are flat.

Positive convex doors have a thickness of 80mm, and negative convex doors have a thickness of 140mm. Positive flat doors have a thickness of 60 mm, and negative flat doors have a thickness of 120 mm.

All models have height-adjustable hinges for easier installation and adjustment of the door with the room, improving the airtightness of the interior once the door is closed. The locking mechanism has a key lock and an interior "knob" opening system.

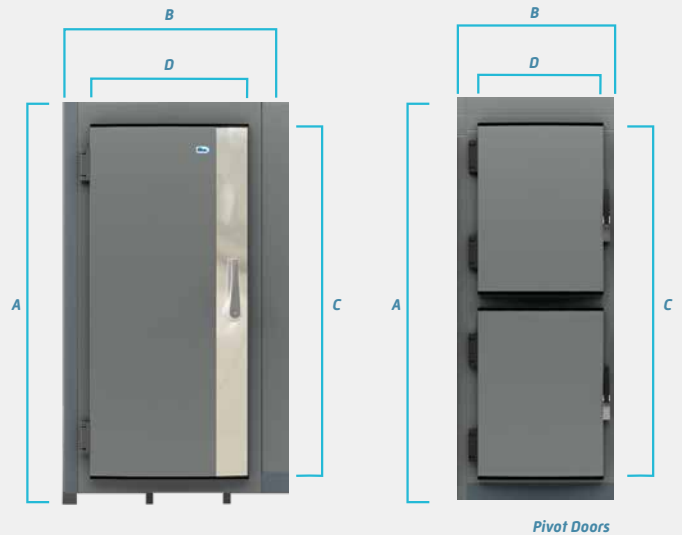

Pivot Doors

AVAILABLE FRAME DIMENSIONS

MATRIX 60 - 85 - 105		MATRIX 150	
Frame A x B	Clearance C x D	Frame A x B	Clearance C x D
2000 x 800	850 x 620*	2000 x 800	850 x 620*
2000 x 1000	850 x 700*	2030 x 800	1900 x 620**
2030 x 800	1900 x 620	2030 x 1200	1900 x 800**
2030 x 1000	1900 x 700	2030 x 1200	1900 x 950**
2030 x 1000	1900 x 800	2430 x 1600	2200 x 1200**
2030 x 1200	1900 x 800	2430 x 2000	2200 x 1500**
2030 x 1200	1900 x 800	-	-
2030 x 1200	1900 x 900	-	-
2430 x 1200	2200 x 1000	-	-
2430 x 1600	2200 x 1200**	-	-
2430 x 2000	2200 x 1500**	-	-

*2 wide opening **These doors have flat stops, not round



Pivot Door

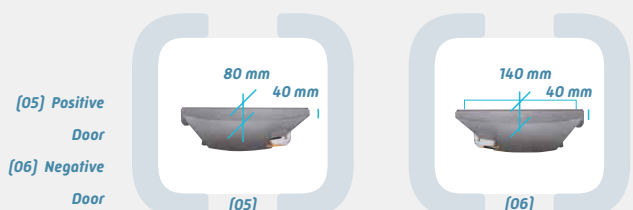

SLIDING DOOR



The new MATRIX sliding door is equipped with a strip and a handle, both made of high-performance AISI 304 stainless steel to give the cold room an elegant, modern design.

For all room models with panel thicknesses of 60, 85, 105 and 150 mm, the sliding door is flat. For positive temperature rooms, the door thickness is 85 mm for panel thicknesses of 60, 85 and 105 mm, and for negative temperature the door thickness is 120 mm for panel thicknesses of 85, 105, 150 mm.

All sliding door models have a new rail made of anodised aluminium with a built-in cover that has been designed to be installed quickly and easily thanks to its clip-on assembly, offering significant time savings compared with other solutions on the market.



Sliding Door

Measurements

MATRIX 60 - 85 - 105 - 150

Frame (min width)	Clearance
2030 x 1200 (2400)	1850 x 950
2430 x 1200 (2400)	2200 x 950
2430 x 1600 (2800)	2200 x 1200
2430 x 2000 (3600)	2200 x 1400
2430 x 2000 (3600)	2200 x 1600

Measurements

Doors 595 x 1700 mm

No. of Doors	Dimensions of the assembly W x H
1	675 x 1780
2	1285 x 1780
3	1895 x 1780
4	2505 x 1780
5	3115 x 1780
6	3725 x 1780

Doors 750 x 1700 mm

No. of Doors	Dimensions of the assembly W x H
1	830 x 1780
2	1595 x 1780
3	2360 x 1780
4	3125 x 1780
5	3890 x 1780
6	4655 x 1780

GLASS DISPLAY DOORS

The rooms can also be equipped with display doors for easier product selection before the room is opened.

These doors have a PVC chassis, 4mm thick tempered glass, and include a 12 mm spacer as well as resistance on the door stops.

It is recommended for temperatures between +2 °C and +20 °C, for environments with up to 70% relative humidity.

These doors are available in the sizes shown. The cold rooms with display doors can also be equipped with white, food-safe, multi-tilt interior shelves. The doors can be supplied to open to the right or to the left, according to the client's needs, and return automatically to the closed position.

The standard lighting of these assemblies involves fluorescent bulbs, although LED is also possible.



[07]



[08]



[09]

- [07] Glass Display Doors
- [08] Multi-tilt interior shelves
- [09] Automatic return to closed position

AUTOMATIC SEMI-RECESSED DOOR



The new MATRIX automatic semi-recessed door has sensors to open it from the outside using feet, hands or both, facilitating access to the room while carrying goods. It also has a flush spyhole for the 60 mm thickness and a perimeter aluminium trim.



Automatic recessed door

GLASS DOOR



The new MATRIX glass door for positive temperature rooms combines the best features and technological advances with an impressive, cutting-edge design.

It is equipped with an integrated temperature and humidity controller and an interactive touch sensor to regulate the light intensity inside the room.



Glass door



NEW LOCK **NEW**

The new MATRIX lock is stronger and more reliable. It has a more attractive design and is integrated into the camera assembly.

This innovative lock not only offers increased durability, ensuring optimum performance in demanding conditions, but also adds a touch of elegance and modernity to the MATRIX.



Floor Panels

MATRIX modular floor panels are made of rigid CFC- and HCFC-free polyurethane. We offer several floor versions depending on the resistance required for the intended use, for both conventional and reinforced service loads, as well as for higher service loads.

In the case of the MATRIX 60, 85 and 105 rooms, the floor panel is 85 mm thick in 200 mm wide modules. However, for the MATRIX 150 rooms, the floor panel is 150 mm thick, the modules being 400 mm wide.



REINFORCED FLOOR PANEL

This floor panel is recommended for conventional service loads. It is made of 10 mm plywood (CTBX), coated with brown non-slip phenolic resin. The material used in the factory is Finnish birch wood.



[10]

SUPER REINFORCED FLOOR PANEL



This is a two-layer floor made of a 6 mm thick wooden base and a 3 mm thick non-slip aluminium surface with a checkerboard pattern. Due to its design, composition and features, using this floor will provide your MATRIX room with the utmost safety and resistance without waiving the best design and appearance.

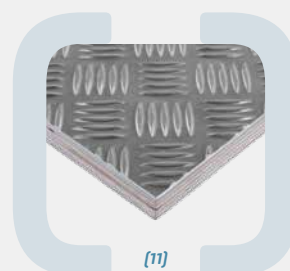

[11]

PANEL DIMENSIONS ACCORDING TO THICKNESS (MM)

Dimensions					
Dimensions (width in mm)					
MATRIX 60 - 85 - 105					
MATRIX 150					
mm	400	600	800	1000	1200
800					
1000					
1200					
1400					
1600					
1800					
2000					
2200					
2400					
2600					
2800					
3000					

HEAVY-DUTY PVC FLOOR PANEL **NEW**

New, heavy-duty PVC floor that protects your MATRIX room from bumps and scratches while giving it a beautiful finish. Thanks to its composition, which provides greater protection from corrosion, this floor maintains its aesthetic appearance for much longer.



[12]

- [10] Reinforced
- [11] Super Reinforced
- [12] Heavy-duty PVC

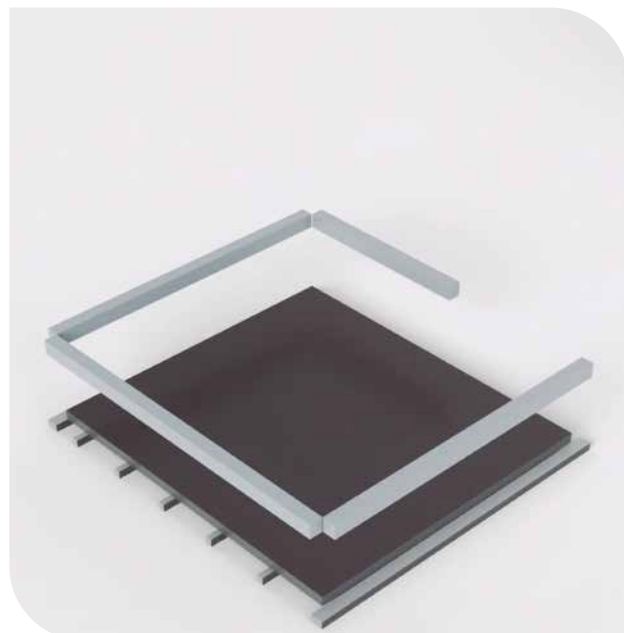

Wall and Ceiling Panels

CALCULATION PARAMETERS

Thermal conductivity, expressed in W/mK or W/m°C, is the amount of energy (in watts) which passes through a surface that is 1 m² and 1m thick, depending on the temperature difference between each of the sides (k or °C). This parameter must be known for polyurethane insulation. It is therefore necessary to conduct laboratory measurements, in accordance with the standards in force, on samples taken from the products made in the factory.

	Value	
MATRIX 60	0,37	W/m ² .°C
MATRIX 85	0,26	W/m ² .°C
MATRIX 105	0,21	W/m ² .°C
MATRIX 150	0,15	W/m ² .°C

Heat transfer K or U, expressed in W/m² K or °C, is the sum of the thermal resistance of each layer of material forming the panel, and the internal and external surface exchange resistances. The value for MATRIX panels is as follows:

PANELS (WALL AND CEILING)

The MATRIX modular wall and ceiling panels are made of high-pressure injected CFC- and HCFC-free polyurethane. The range of MATRIX wall and ceiling panels includes 4 thicknesses, depending on the client's refrigeration needs: 60, 85, 105 and 150 mm.

The temperature ranges inside the room and the recommended applications for each panel thickness range from +8° to -40°.

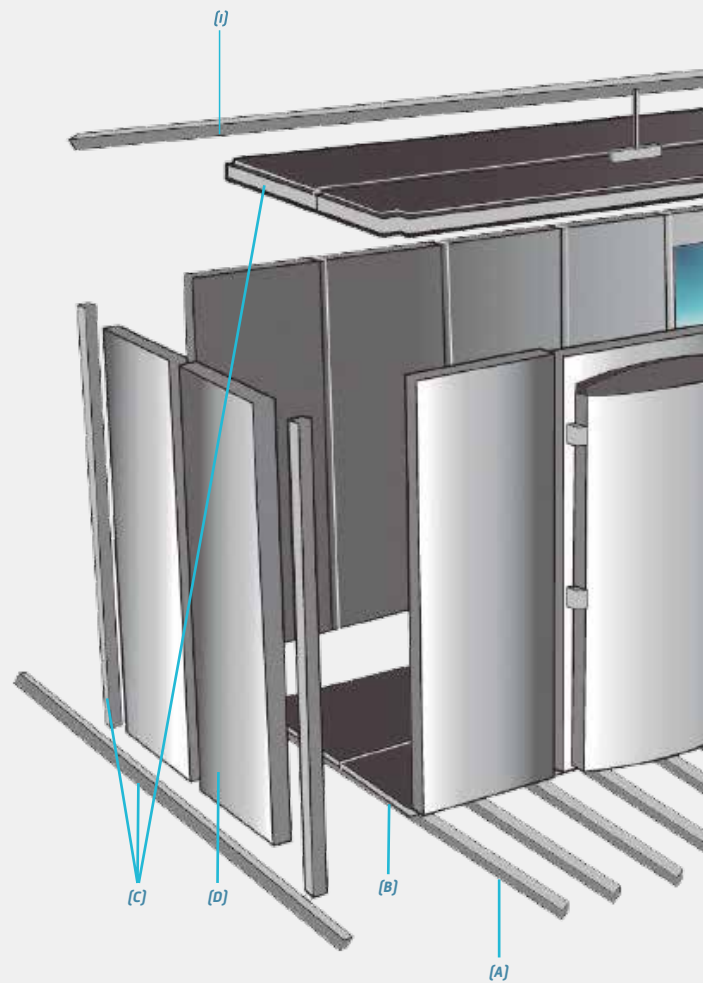

- (A) Sanitary Gap Profile
- (B) Floor Panel
- (C) Rounded angles (Walls / Ceiling and Floor)
- (D) Wall Panel
- (E) Door
- (F) Window Panel
- (G) Ceiling Panel
- (H) Floor Belt
- (I) Roof support (Optional/Self-supporting)

Each of the panels has the following modules, expressed in metres, in order to adapt correctly to the configuration of the space reserved for the cold room.

MATRIX 60, 85 and 105 wall and ceiling panel modules are **200 mm** in height and width and **MATRIX 150** are **400 mm** in height and width.

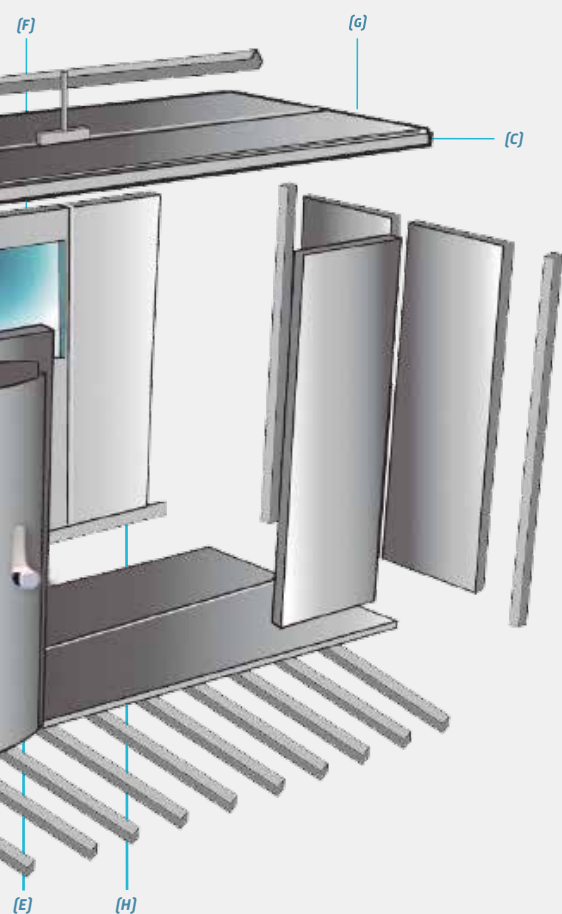

PANEL COATING

In their standard configuration, the panels forming the MATRIX cold room have the following coatings:

- Outer side: coating made of pre-lacquered galvanised steel sheet with 25-micron polyester varnish. Basalt grey colour reference RAL 7012, 0.50 mm thick, with polyethylene protective film.
- Inner side: coating made of pre-lacquered galvanised steel sheet with 25-micron polyester varnish. White colour reference RAL 1006, 0.50 mm thick, with polyethylene protective film.

INNER AND OUTER PANEL COATING OPTIONS

In addition to the white and basalt grey coating used in the standard configuration, we offer a smooth stainless steel coating made of brushed AISI304 stainless steel sheet. This is 0.60 mm thick and is protected by polyethylene film.

This way, by selecting one option for the inner side and another for the outer side from the three coating options we offer, you have up to six different combinations for your MATRIX:

- Inner White/Outer Basalt Grey
- Inner White/Outer White
- Inner White/Outer Stainless Steel
- Inner Stainless Steel/Outer Basalt Grey
- Inner Stainless Steel/Outer White
- Inner Stainless Steel/Outer Stainless Steel



In addition, we now offer the possibility of including a heavyduty PVC coating on the inner side of your room panels to protect the inside of your MATRIX from bumps and scratches. You decide the height and width of this special coating, as it can be applied to the entire panel or to just a specific section of the panel. As the strip is factory-integrated into the panel itself, it remains unaltered over time and requires no special maintenance.



Interior PVC coating

Thickness			
MATRIX 60 - 85 - 105		MATRIX 150	
Width	Height	Width	Height
-	2000	-	2000
-	2200	-	-
-	2400	-	2400
400	2600	400	-
600	2800	-	2800
800	3000	800	-
1000	3200	-	3200
1200	3400	1200	-
-	3600	-	3600
-	3800	-	-
-	4000	-	4000

PANEL ASSEMBLY

All wall and ceiling panels are fitted at the time of manufacture with universal plastic camlocks equipped with a hook and pin (patented model) to adapt to 200 mm modulation (400 mm for MATRIX 150). In addition, to ensure a perfect combination of assembly systems, the moulds used during the manufacturing process have been designed for the accurate positioning of the camlocks.

The MATRIX 150 wall and ceiling panels guarantee insulation continuity. A polyethylene filling provided with the room must be applied at the joint between the two panels, and between panels and corners during assembly. A few drop of silicone must be applied to keep them in place.

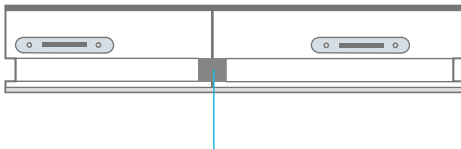

MATRIX 150: 30x20 mm insulation between 2 panels

ASSEMBLY METHOD

Each box has a hook and shaft set. In addition, the grey polyethylene adhesive bonding on the side of each box must be noted. When closed, this enables the panels to remain compressed to ensure a perfect seal. To install, simply turn the hexagonal key previously inserted into the slot for this purpose by 45°.

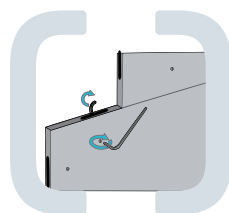
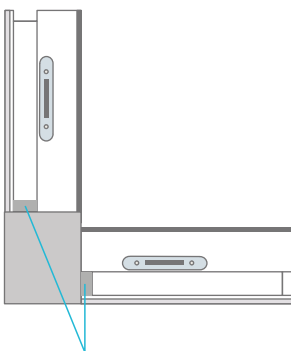

MATRIX 150: 30x10 mm insulation between panels and corners

Technical Data

Wall and ceiling panels				
	MATRIX 60	MATRIX 85	MATRIX 105	MATRIX 150
Conductivity coefficient	0,37 W/m ² . °C	0,26 W/m ² . °C	0,21 W/m ² . °C	0,15 W/m ² . °C
ΔT usual temperature (Q) for heat loss 13 W/m ²	35 °C	50 °C	60 °C	85 °C
Tensile strength perpendicular to the front. According to UNE 41950-94	0,12 N/mm ²			
Dimensional stability. According to UNE 41950-94. After 24 h at 80 °C. After 24 h at -20 °C.	0,5 % in volume 0,2 % in volume			

THERMAL AND PHYSICAL FEATURES

- The thermal conductivity coefficient of polyurethane, in accordance with Standard DIN 52612, is equal to: 0.0228 W/m°C.
- Similarly, the density of polyurethane, in accordance with Standard UNE 92235 is equal to: 40 +/- 2 kg/m³.
- The compressive strength, in accordance with Standard UNE 92334 is equal to: 0.15 N/mm².

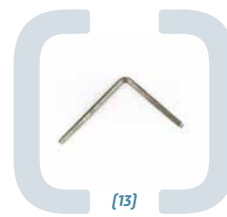

[13]



[14]



[15]

[13] Key

[14] Male box + female box

[15] Set

AVAILABLE DIMENSIONS

The different combinations of thickness, length and height available for MATRIX wall and ceiling panels are given below.

Dimensions					
Dimensions (width in mm)					
MATRIX 60 - 85 - 105					
mm	400	600	800	1000	1200
200					
400					
600					
800					
1000					
1200					
1400					
1600					
1800					
2000					
2200					
2400					
2600					
2800					
3000					
3200					
3400					
3600					
3800					
4000					

Dimensions			
Dimensions (width in mm)			
MATRIX 150			
mm	400	800	1200
400			
800			
1200			
1600			
2000			
2400			
2800			
3200			
3600			
4000			

Dimensions			
Dimensions (width in mm)			
BANDEAUX			
mm	400	800	1200
400			
800			
1200			
1600			
2000			
2400			



Window Panels

PANEL WITH STANDARD WINDOW

MATRIX 60 and MATRIX 85 offer the possibility of including levelled glass on both sides of the 1200 mm wide panel and of the same thickness as the panel (60 mm or 85 mm). This glass is formed by two 6 mm panes of glass joined together on an aluminium profile. The vacuum produced at the time of adhesion guarantees stability between the panes, as well as a perfect seal in the silicone to avoid any risk of condensation.



NEW PANEL WITH INTERACTIVE TOUCH WINDOW



MATRIX 60 offers the possibility of including a panel with this revolutionary window that not only enables you to see the inside of your cold room but also allows you to switch on the light inside or open the door by simply touching it from outside, among other possibilities. It has a perimeter trim frame made of aluminium and is only available for 60 mm thick panels in positive temperature rooms.

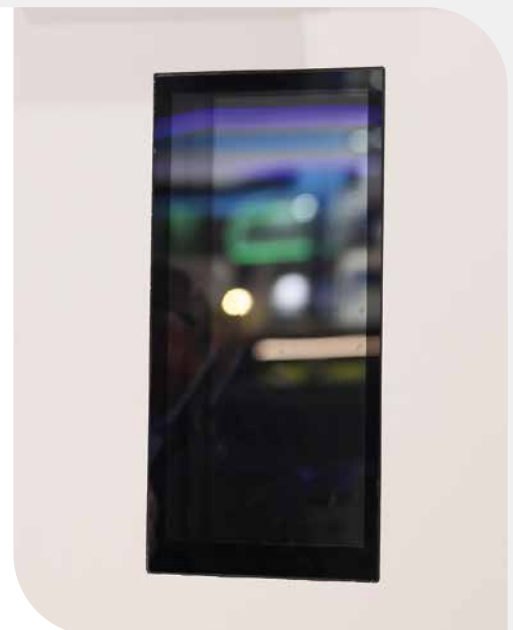



Measurements

H = 2000				
MODEL	A	B	C	D
1	1200	800	800	200
2	1200	800	1200	200
3	1200	800	1200	400
4	1200	800	1600	200

H = 2200				
MODEL	A	B	C	D
1	1200	800	800	400
2	1200	800	1200	200
3	1200	800	1200	500
4	1200	800	1600	300

H = 2400				
MODEL	A	B	C	D
1	1200	800	800	600
2	1200	800	1200	400
3	1200	800	1200	600
4	1200	800	1600	400

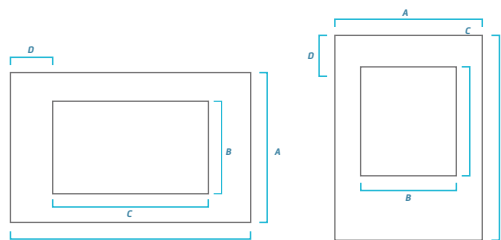

Angles

The **MATRIX 60, 85** and **105** modular rooms can be installed with or without a floor panel, depending on the intended use of the equipment (storage, freezing, etc.).

The **MATRIX 150** room is intended for use at negative temperatures and **will therefore always be installed with a floor**.

The following designs represent each of the possible alternatives in the assembly of the different rooms.

TYPES OF CORNERS



[16] Inner Connection Angle

FLOOR RACK

The floor reinforcement consists of a PVC profile with a single height of 30 mm and widths: 60 mm, 85 mm, 105 mm, respectively, for the MATRIX 60, 85, 105. This reinforcement is normally suitable for rooms without a floor, to attach the wall panels. In this case, the screws included in the assembly kits are used to attach it directly to the floor where the cold room is to be erected. It is also used vertically and horizontally in the case of MATRIX 60, 85 and 105 rooms, the walls of which are attached to a wall made of traditional materials. Its name is the G, H and J-type angle.

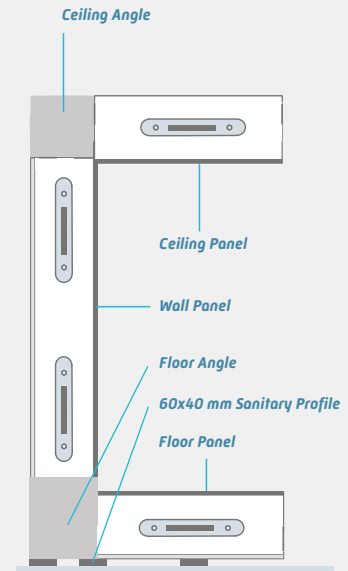
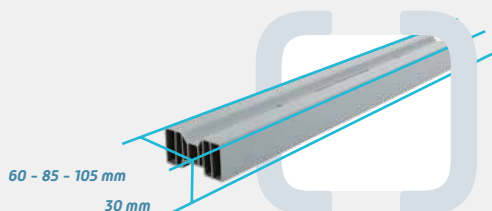

MATRIX 60, 85 and 105 - WITH FLOOR

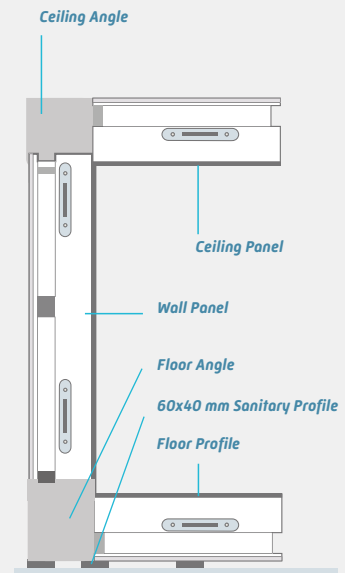

MATRIX 150 - WITH FLOOR

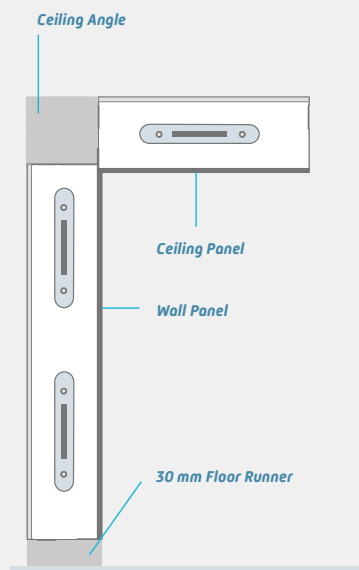

MATRIX 60, 85 and 105 - WITHOUT FLOOR



INSULATED FLOOR RUNNER

This is a principle for assembly without floor panels, which can only be used for insulated concrete floors. Assembly is as follows:

1. The 30 mm floor reinforcements corresponding to the perimeter of the room are placed on the concrete (with the exception of the clearance for the doors to open and close). They are attached to the floor using plastic plugs and a screw, both included in the assembly kit.
2. The insulated runners are then fitted, using the camlocks on the centrelines of the 30 mm runners. Use the pin included in the assembly kit for this purpose.
3. The wall panels are then assembled by connecting the camlocks on the insulated runner, in line with the same principle. These runners are available for each panel thickness, 60, 85, 105 and 150 mm, and in three heights: 180, 200 and 240 mm.

INSULATED FLOOR SUPPORT

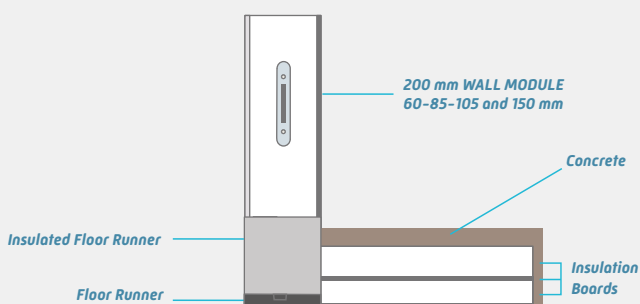

USE AND TYPES OF ANGLES

For types **E** and **A**, on the **MATRIX 105** and **150**, the difference is the direction: Left for type A and right for type E.

FLOOR PLANS

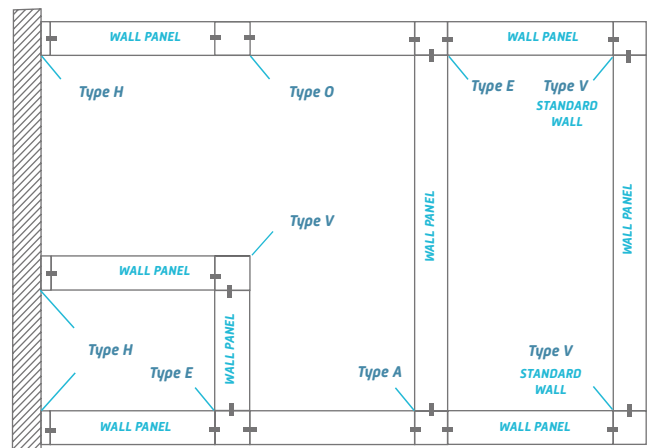

FLOOR

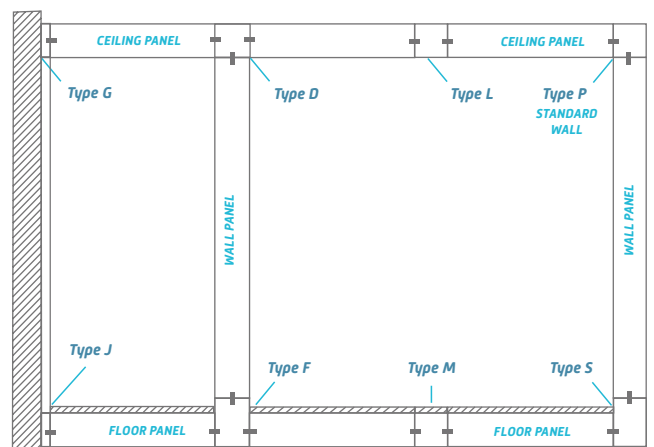

WALL AND CEILING ANGLE

All MATRIX wall and ceiling angles are available in the following lengths (their widths will be the same as the MATRIX models 60, 85, 105 or 150 mm selected).

MATRIX 60

Made of RAL 7012 grey PVC with a 60x60 mm square cross-section, not injected with polyurethane.

The outer wall angle is rounded for easier cleaning and has two sides for attachment to the wall panels. Used for versions:

White/Grey, Stainless Steel/Grey, Stainless Steel/Stainless Steel, White/Stainless Steel and White/White.

For all other versions with **White/White and Stainless Steel/White**, coating, as well as the 3-way ceiling angles Type E and D and 2-way L and O (for connected rooms), a PVC 60x60 mm square cross-section profile is used, in White or Grey, not injected with polyurethane.

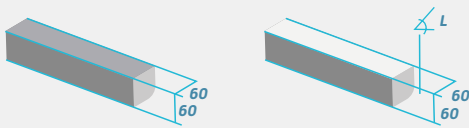

2-way		3-way	
CEILING	WALL	CEILING	WALL
800	1630	800	1630
885	1715	1000	1715
1000	1800	1200	1800
1085	2000	1400	2000
1200	2030	1600	2030
1285	2115	1800	2115
1400	2200	2000	2200
1485	2230	2200	2230
1600	2315	2400	2315
1800	2400	2600	2400
2000	2430	3000	2430
2200	2515	3200	2515
2400	2630	-	2630
2600	2715	-	2715
2800	2830	-	2830
3000	2915	-	2915
3200	3030	-	3030
-	3115	-	3115
-	3320	-	3230
-	3315	-	3315

MATRIX 85

Made of RAL 7012 grey PVC with a 85x85 mm square cross-section, injected with polyurethane. The outer wall angle is rounded for easier cleaning and has two sides for attachment to the wall panels. Used for the White/Grey and Stainless Steel/Grey coated versions.

For the versions with White/White and Stainless Steel/White coating, as well as the 3-way ceiling angles Type E and D and 2-way L and O (for connected rooms), a PVC 85x85 mm square cross-section profile is used, in White or Grey, injected with polyurethane.

For all other versions with White/White and Stainless Steel/White coating, which are 2- or 3-way, the 85x85 mm square cross-section angles with stainless steel sheet are connected by a polyurethane-injected plastic profile.

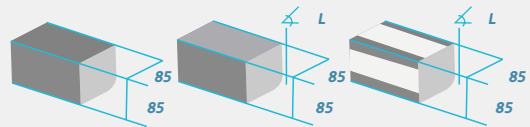

2-way		3-way	
CEILING	WALL	CEILING	WALL
800	1600	800	1600
885	1630	1000	1630
1000	1715	1200	1715
1085	1800	1400	1800
1200	2000	1600	2000
1285	2030	1800	2030
1400	2115	2000	2115
1485	2200	2200	2200
1600	2230	2400	2230
1800	2315	2600	2315
2000	2400	2800	2400
2200	2430	3000	2430
2400	2515	3200	2515
2600	2630	-	2630
2800	2715	-	2715
3000	2830	-	2830
3200	2915	-	-
-	3030	-	-
-	3115	-	-



MATRIX 105

Made of RAL 7012 grey PVC with a 105x105 mm square cross-section, injected with polyurethane. The outer wall angle is rounded for easier cleaning. It has two doubled sided wings to attach the wall panels. This angle is used for White/Grey and Stainless Steel/Grey coated versions.

For the versions with White/White and Stainless Steel/White coating, as well as the 3-way ceiling angles Type E + A (right and left) and D, and 2-way Type L and O (for connected rooms), a PVC 105x105 mm square cross-section profile is used, in White or Grey, injected with polyurethane.

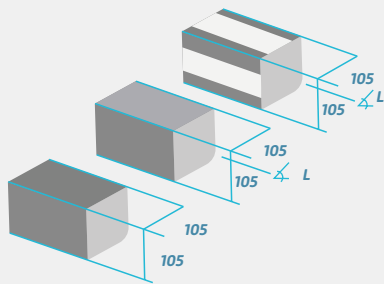

2-way		3-way	
CEILING	WALL	CEILING	WALL
800	1600	800	1600
885	1630	1000	1630
1000	1715	1200	1715
1085	1800	1400	1800
1200	2000	1600	2000
1285	2030	1800	2030
1400	2115	2000	2115
1485	2200	2200	2200
1600	2230	2400	2230
1800	2315	2600	2315
2000	2400	2800	2400
2200	2430	3000	2430
2400	2515	3200	2515
2600	2630	-	2630
2800	2715	-	2715
3000	2830	-	2830
3200	2915	-	2915
-	3030	-	3030
-	3115	-	3115

MATRIX 150

For all other versions with **Stainless Steel/Stainless Steel and White/Stainless Steel**, coating, 2 or 3-way, the 105x105mm square cross-section angle made of stainless steel sheet with polyurethane-injected plastic is used.

This angle has a square cross-section of 150x150 mm and is made of stainless steel sheet or pre-lacquered steel sheet (depending on the inner and outer coating of the panels) connected to a plastic profile and injected with polyurethane. Available in 2-way for standard rooms, in 2-way Type L and O or in 3-way Type E and D, for connected rooms.

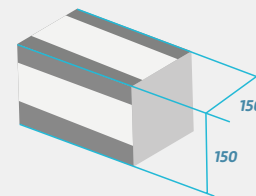

2-way		3-way	
CEILING	WALL	CEILING	WALL
800	1630	800	1630
950	1750	1200	1750
1200	1780	1600	1780
1350	2180	2000	2180
1600	2330	2400	2330
1750	2580	2800	2580
2000	2730	3200	2730
2150	2980	-	2980
2400	3130	-	3130
2800	-	-	-
3200	-	-	-

FLOOR ANGLE

MATRIX floor angles are available in the following sizes:

MATRIX 60

The MATRIX 60 floor angle is standard and is 2 or 3-way. It is made of PVC and has a rectangular cross-section of 115x60 mm injected with polyurethane.

- **RAL 7012 GREY** for White/Grey, Stainless Steel/Grey, White/Stainless Steel, Stainless Steel/Stainless Steel versions.
- **WHITE** for White/White and Stainless Steel/White versions.

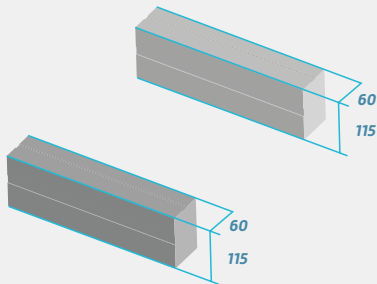

MATRIX 85

The MATRIX 85 floor angle is standard and is 2 or 3-way. It is made of PVC and has a rectangular cross-section of 115x85 mm injected with polyurethane, in two colours depending on the coating of the room:

- **RAL 7012 GREY** for **White/Grey, Stainless Steel/Grey, Stainless Steel/Stainless Steel and White/Stainless Steel** versions.
- **White** for **White/White and Stainless Steel/White** versions.

For Stainless Steel/Stainless Steel and White/Stainless Steel coating versions. The 115x85 mm rectangular cross-section angle is made of stainless steel sheet connected to 1 plastic profile which, in turn, guarantees heat insulation, injected with polyurethane.

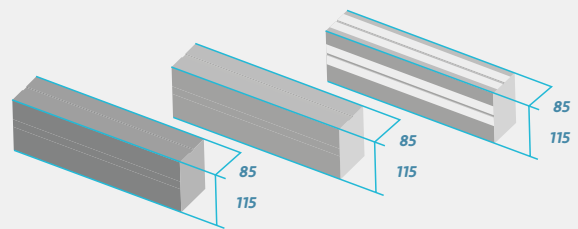

Dimensions

		Matrix 60	Matrix 85	Matrix 105	Matrix 105		
LENGTH	HEIGHT	WIDTH			LENGTH	HEIGHT	WIDTH
400	115	60	85	105	400	180	150
600	115	60	85	105	-	-	-
800	115	60	85	105	800	180	150
1000	115	60	85	105	-	-	-
1200	115	60	85	105	1200	180	150
1400	115	60	85	105	-	-	-
1600	115	60	85	105	1600	180	150
1800	115	60	85	105	-	-	-
2000	115	60	85	105	2000	180	150
2200	115	60	85	105	-	-	-
2400	115	60	85	105	2400	180	150



MATRIX 105

For all versions, the 115x105 mm rectangular crosssection angle is made of stainless steel sheet or prelacquered steel sheet (depending on the inner and outer coating of the panels) connected to 1 plastic profile and injected with polyurethane.

Depending on the version, it will have the following features:

- **White/Grey and Stainless Steel/Grey**, the outer sheet is RAL 9006 GREY and the 30 mm part visible on the inside is 1006 WHITE or STAINLESS STEEL.
- **Stainless Steel/Stainless Steel or White/Stainless Steel**, the outer sheet is Stainless Steel and the 30 mm part visible on the inside is 1006 WHITE or STAINLESS STEEL.
- **White/White or Stainless Steel/White**, the outer sheet is 1006 WHITE and the 30mm part visible on the inside is 1006 WHITE or STAINLESS STEEL.

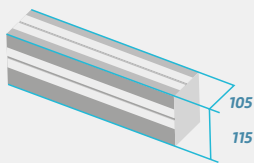

MATRIX 150

For all versions, the 180x150 mm rectangular crosssection angle is made of stainless steel sheet or prelacquered steel sheet (depending on the internal and external coating of the panels), connected to 1 plastic profile injected with polyurethane.

Depending on the version, it will have the following features:

- **White/Grey and Stainless Steel/Grey**, the outer sheet is RAL 9006 GREY and the 30 mm part visible on the inside is 1006 WHITE or STAINLESS STEEL.
- **Stainless Steel/Stainless Steel or Stainless Steel/White**, the outer sheet is 1006 WHITE and the 30 mm part visible on the inside is 1006 WHITE or STAINLESS STEEL.
- **White/White and Stainless Steel/White**, the outer sheet is 1006 WHITE and the 30 mm part visible on the inside is 1006 WHITE or STAINLESS STEEL.

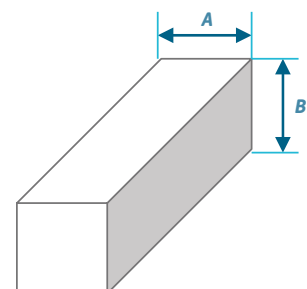
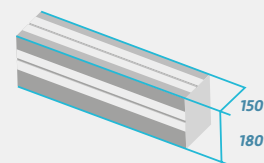

Assembly Add-ons and Accessories

STRIP CURTAIN

These consist of PVC strips with hinged polyethylene supports mounted on PVC pipe. The transparent strips are 200 mm in width and 2 mm thick.



Strip curtain

ACCESS RAMP



The new MATRIX access ramp has a galvanised steel structure and is coated in non-slip aluminium. Thanks to its design and characteristics, it is a lightweight and easy to move yet extremely strong, as it is capable of withstanding up to 800 kg of dynamic load.

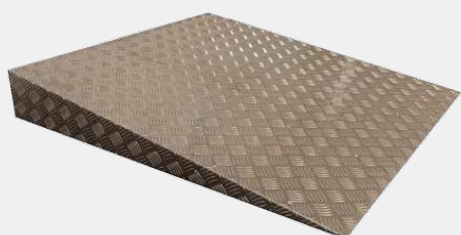

SILL



New sill made of injected PVC which improves the mechanical resistance compared with previous models. Furthermore, the use of PVC in this key part of our MATRIX room eliminates the appearance of biological risks associated with the use of other organic materials such as wood (e.g. fungal growth).



DATA LOGGER



With our new Data logger, you will now be able to know and control the environmental conditions inside your MATRIX room at any time and from anywhere. Using an APP on your mobile phone, you can access the temperature and humidity inside your room and receive alerts if certain set levels are reached. Thanks to this device, which includes an easy magnetic installation, the traceability of the conditions in which your products are stored is guaranteed.



Data logger

SANITARY GAP PROFILE

This is a 60x40 mm rectangular PVC profile intended to improve the floor level for floor assembly, and to ensure the passage of water in rooms exposed to the weather and avoid condensation in the sub-structure of the refrigerated area.

In addition, positioned parallel to each other every 400 mm and correctly adjusted using a spirit level, they ensure the floor panels are positioned without any misalignment between them.

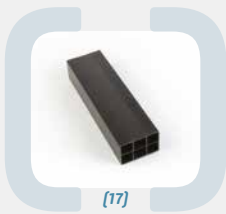

[17]



[18]



[19]

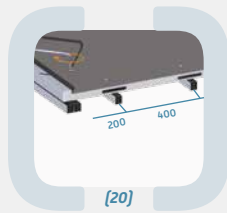

[20]

[17] Sanitary Gap Profile
[18] Cover
[19] Assembly

[20] Pay special attention to the position of the holes under the floor profiles

SANITARY PROFILE KIT

The sanitary profile **kits** consist of 2 parts, the PVC channel which is attached to the wall and the white PVC profile rounded in a quarter circle, clipped into this channel. For this purpose, each corner of the room includes a finishing piece known as an angle corner.



[21]

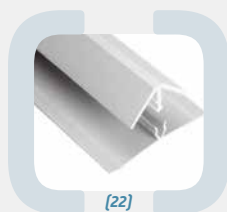

[22]

[21] Inner Corner and Outer Corner
[22] Sanitary Profile

CEILING SUPPORTS

There are several possibilities for the support of this component:

SELF-SUPPORTING PANEL

The panel is considered self-supporting and rests on the walls when the maximum width of the room is less than or equal to the permissible span (A).

Panel				
Thickness	60 mm	85 mm	105 mm	150 mm
Maximum W	4000 mm	4800 mm	5500 mm	6000 mm
No. of Attachments	2	2	2	2

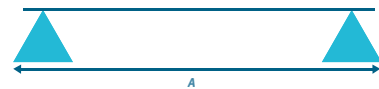

PANEL SUSPENDED ON THE STRUCTURE

The distance between axes of the suspension points must, in this case, be \leq the permissible span of the ceiling panels. Each suspension point is attached to a camlock for distances between axes < 3.20 m and to two camlocks for attachments that are further away.

For both types of panel, the technical information is as follows:

- Total load 60 da N/m²
- Sag $\leq 1/200$ of the range
- Safety against breakage
- Compatibility with attachment resistance

When the width of the room is greater than the span of the ceiling panels, 2 types of structure are proposed that will make the panel self-supporting:

120 OMEGA

Span of the Structures Width of the Room in mm	Maximum Distance between axes of the Structures
3600	3200
3800	3200
4000	3200
4200	3200
4400	3200
4800	3200
5000	2400
5200	2400
5400	2000
5600	1600
5800	1600
6000	1600

AUXILIARY STRUCTURE

The 320 mm auxiliary metal structure is suitable for cold rooms with an inner size between 6 and 14.80 mm.

The basis for calculating the distance between axes of these structures is as follows:

- Total load 40 kg/m² for open construction and 50 kg/m² in closed construction
- Permissible sag $\leq 1/200$ of the span
- 1 single ceiling support per panel when the length is ≤ 3.20 m
- 2 ceiling supports per panel when the length is > 3.20 m

CEILING SUPPORT

This stainless steel part is intended for the recovery of ceiling panels in the 3 cases of assembly indicated above (suspension on the construction, suspension with an omega or suspension with metal lattice). It is supplied with the room only in these 3 cases of assembly. The ceiling support is inserted between 2 camlocks and is attached using pins.

After locating the position of the suspensions on the plan supplied with the room, prepare their placement in the following diagram.

After installing the panels, the cavity around the threaded rods must be filled with silicone. Then tighten the nut on the plastic sealing washer. This washer has a protruding part that is inserted into the panel connection.

METHOD OF POSITIONING CEILING PANEL SUPPORTS

It is very important to follow all these instructions closely, especially those regarding watertightness which must be correct on the outside of the ceiling panel.

Maximum Distance between Axes of the Structures		
Span of the Structure Width of the Room in mm	Open Construction	Closed Construction
640	600	600
660	600	600
680	600	600
700	600	600
720	600	600
740	600	600
760	600	600
780	600	600
800	600	600
820	600	600
840	600	600
860	600	600
880	600	600
900	600	600
920	560	600
940	560	600
960	520	600
980	520	600
1000	440	560
1020	320	560
1040	320	480
1060	320	440
1080	320	440
1100	320	440
1120	320	400
1140	320	400
1160	240	360
1180	240	360
1200	200	320
1220	160	320
1240	160	280
1260	160	280
1280	200	280
1300	200	280
1320	200	240
1340	200	240
1360	160	240
1380	160	240
1400	160	200
1420	160	200
1440	160	200
1460	160	200
1480	160	160

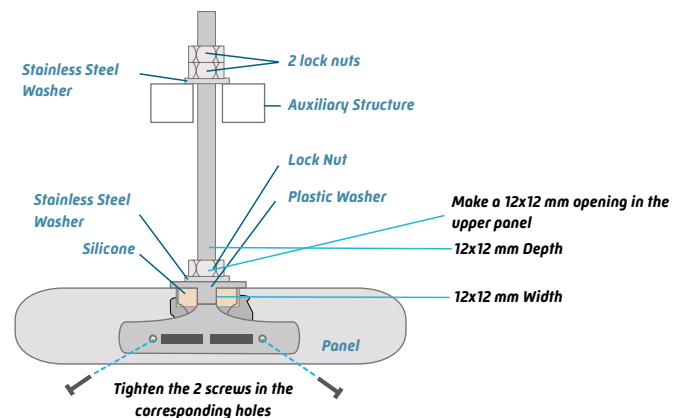

- [23] Auxiliary Structure
- [24] Support for Auxiliary Structure
- [25] Auxiliary Structure and Support
- [26] Structure Omega

SURBASE OR SKIRTING BOARD

The surbases or skirting boards are white PVC profiles that are attached to the base of the wall panels to ensure their protection. For this purpose, there are PVC parts that fit in the corners of the room and on the ends of the profiles.



[27] Surbase

[28] Skirting Board

PRESSURE-BALANCED VALVE

The assembly instructions for the cold room are supplied with a complete guide for its installation. There are two types of compensating valves, the use of which will depend on the volume of the cold store, in line with the following table:

Temperature Inside the Room					
VOLUME (m³)	<-30*	<-20	<-15	<-10	<-5
<20	1*	1	1	1	1
<50	1*	2	2	2	2
<100	1*	1*	1*	1*	1*

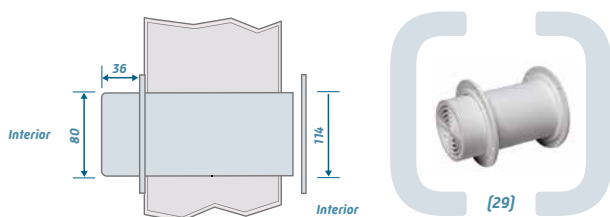

[29] Pressure-Balanced Valve T2-21

SHEET METAL PROFILES

The bent flat, L-, U- or Z-shaped profiles are available in 3 versions of coating:

- Stainless steel
- Pre-lacquered WHITE reference 1006
- Grey (RAL 9006)

These profiles are used for attachment on the wall panel and on the ceiling at movable intermediate partitions to cover exposed panels to improve the finish of a room.

CONVENTIONAL MODULAR SHELVING



MATRIX can be equipped with shelving made of 15-micron anodised aluminium and certified for sanitary use.

According to the philosophy of Coldkit products, these shelves combine a functional and elegant design with quick and simple assembly, designed for easy cleaning and maintenance.

Their materials also guarantee a capacity per shelf of between 100 and 120 kg. The adjustable feet and the possibility of different levels (up to 10), along with the possibility of angular assemblies, mean they adapt perfectly to the inside space of the room.



COLDKIT

Keep Fresh

PUREVER
INDUSTRIAL SOLUTIONS

PUREVER  INDUSTRIES
Protecting Life

PUREVER INDUSTRIAL SOLUTIONS

Zona Industrial de Nelas
Lugar do Poço Forrado, Apartado 7
3521-909 Nelas (Viseu)

T +351 232 941 280
info@coldkit.com

www.coldkit.com
www.pureverindustrialsolutions.com